

Fast, Effective Impact Cleaning

Alfa Laval TJ MultiJet 40 Rotary Jet Head

Application

The Toftejorg MultiJet 40 rotary jet head provides 3D indexed impact cleaning over a defined time period. It is ideal for applications where cost-effective impact cleaning with rotary jet heads is needed, but where compliance with hygienic design standards is not a requirement. The device is suitable for process, storage and transportation tanks between 50 and 500 m³. It is designed to work under conditions where fibres, finer particles, etc. in the cleaning media may be re-circulated through the machine.

Working principle

The flow of the cleaning fluid makes the nozzles perform a geared rotation around the vertical and horizontal axes. In the first cycle, the nozzles lay out a coarse pattern on the tank surface. The following cycles make the pattern gradually more dense, until a full pattern is reached after 8 cycles.



TECHNICAL DATA

Lubricant: Self-lubricating with the cleaning fluid
 Max. throw length: 8 - 17 m
 Impact throw length: 4 - 10 m

Pressure

Working pressure: 3 - 12 bar
 Recommended pressure: 5 - 6.5 bar

Cleaning Pattern

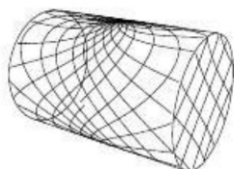

First cycle

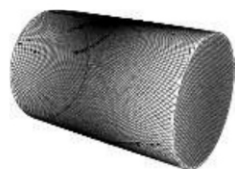

Full pattern

The above drawings show the cleaning pattern achieved on a cylindrical horizontal vessel. The difference between the first cycle and the full pattern represents the number of additional cycles available to increase the density of the cleaning.

Certificates

2.1 material certificate and ATEX.

PHYSICAL DATA

Materials

316L (UNS S31603), PTFE, PEEK, ETFE, FPM, TFM
 Surface finish: Exterior finish: glass blasted

Temperature

Max. working temperature: 95 °C
 Max. ambient temperature: 140 °C

Weight: 6.1 kg

Connections

Standard female thread: 1½" Rp (BSP) or 1½" NPT

Options

Electronic rotation sensor to verify 3D coverage.

Caution

Do not use for gas evacuation or air dispersion.

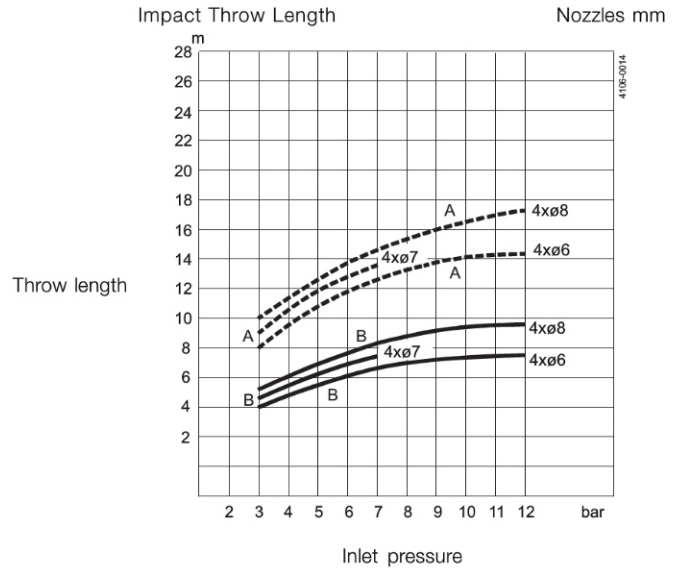
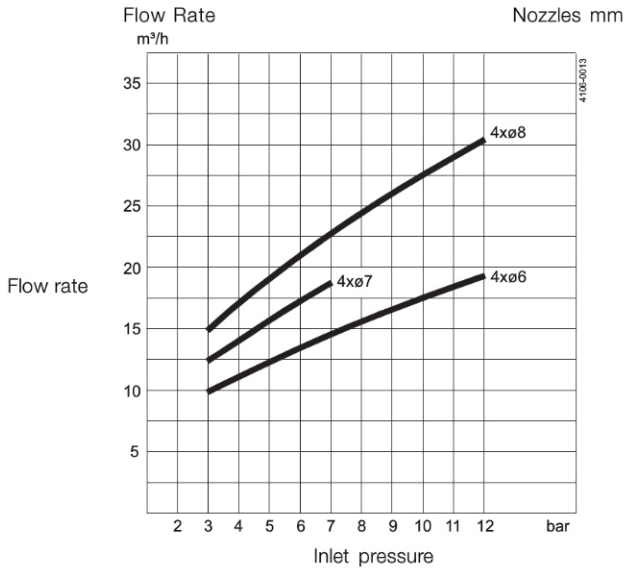

Dimensions (mm)

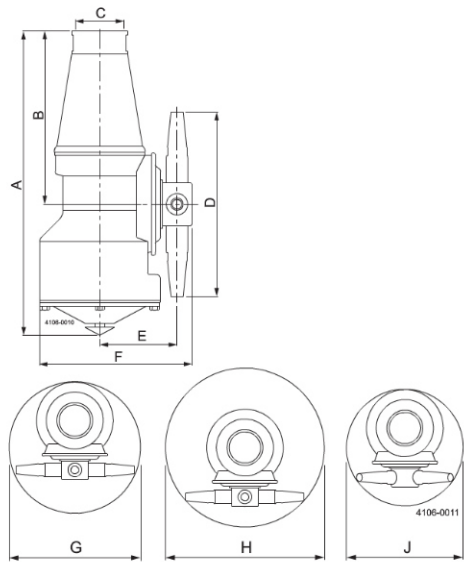

Cleaning Time, Complete Pattern
Min. RPM of machine body
PTM (Pattern time minutes)

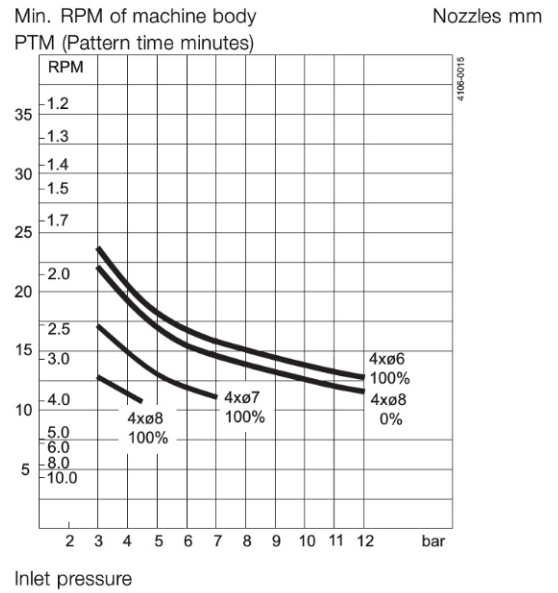

A	B	C	D	E	F	G	H	J
297	170	1½" BSP or 1½" NPT	204	78	152	ø216	ø264	ø180

Standard Design

The choice of nozzle diameters can optimise jet impact length and flow rate at the desired pressure. As standard documentation, the Toftejorg MultiJet 40 can be supplied with a "Declaration of Conformity" for material specifications.

TRAX simulation tool

TRAX is a unique software that simulates how the Toftejorg MultiJet 40 performs in a specific tank or vessel. The simulation gives information on wetting intensity, pattern mesh width and cleaning jet velocity. This information is used to determine the best location of the tank cleaning machine and the correct combination of flow, time and pressure to implement.

A TRAX demo containing different cleaning simulations covering a variety of applications can be used as reference and documentation for tank cleaning applications. The TRAX demo is free and available upon request.

Wetting Intensity

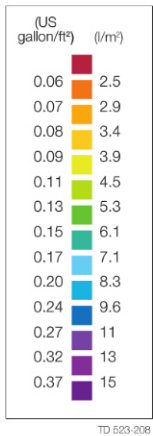

D5m H6m, Toftejorg MultiJet 40, 4 x ø6 mm, 100% Time = 4.3 min., Water consumption = 887 l

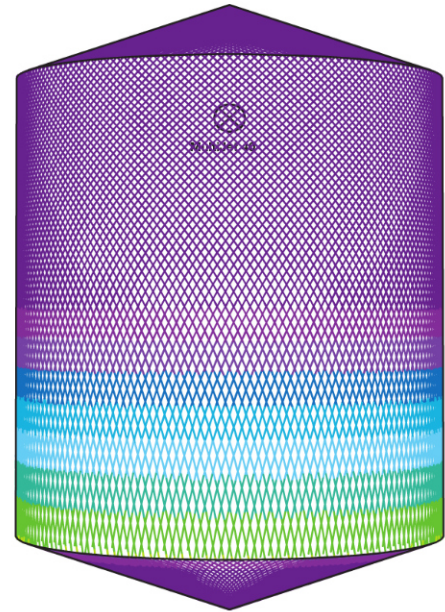

D5m H6m, Toftejorg MultiJet 40, 4 x ø6 mm, 100% Time = 18.2 min., Water consumption = 3760 l

