

## Award-Winning Design

### Alfa Laval TJ 20G Rotary Jet Head

**Application**

The Tofteborg TJ 20G rotary jet head provides 3D indexed impact cleaning over a defined time period. It is automatic and represents a guaranteed means of achieving quality assurance in tank cleaning. Used in breweries, food and dairy processes and many other industries, the device is suitable for processing, storage and transportation tanks and vessels between 15 and 150 m<sup>3</sup>. The award-winning design is particularly suitable for hygienic industries that follow European Hygienic Equipment Design Group guidelines.

**Working principle**

The flow of the cleaning fluid makes the nozzles perform a geared rotation around the vertical and horizontal axes. In the first cycle, the nozzles lay out a coarse pattern on the tank surface. The subsequent cycles gradually make the pattern more dense, until a full pattern is reached after 8 cycles.



**TECHNICAL DATA**

Lubricant: . . . . . Self-lubricating with the cleaning fluid  
 Standard Surface finish: . . . . . Exterior surface finish Ra 0.5µm  
 Max throw length: . . . . . 9 - 14 m  
 Impact throw length: . . . . . 4 - 8 m  
 Standard thread: . . . . . 1" Rp (BSP) or NPT, female Top cone.  
 . . . . . 1" Rp (BSP) with sanitary seal

**Pressure**

Working pressure: . . . . . 3-8 bar  
 Recommended pressure: . . . . . 5-6.5 bar

**Cleaning Pattern**

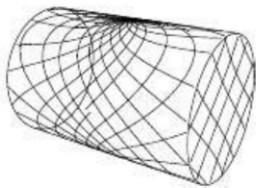

First cycle



Full pattern

The above drawings show the cleaning pattern achieved on a cylindrical horizontal vessel. The difference between the first cycle and the full pattern represents the number of additional cycles available to increase the density of the cleaning.

**Certificates**

2.2, 3.1 material certificate and ATEX.

**PHYSICAL DATA**

**Materials**

316L (UNS S31603), Duplex steel (UNS N31803), EPDM, PEEK, PVDF, PFA

**Temperature**

Max. working temperature: . . . . . 95°C  
 Max. ambient temperature: . . . . . 140°C

**Weight:** . . . . . 5.1 kg

**Options**

Electronic rotation sensor to verify 3D coverage.

**Caution**

Avoid hard and abrasive particles in the cleaning liquid, as this can cause increased wear and/or damage of internal mechanisms. In general, a filter in the supply line is recommended. Do not use for gas evacuation or air dispersion.

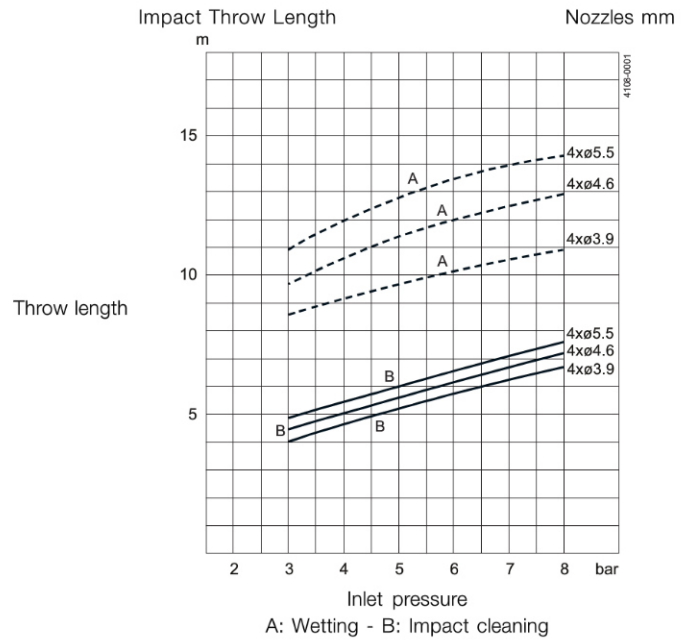
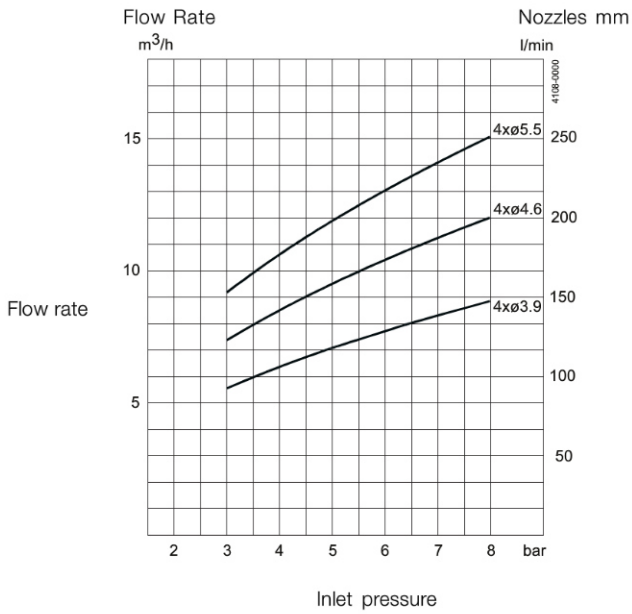

Distillery version - flow at 5 bar / 72.5 PSI  
 4 x ø3.9 = 10 (m³/h)  
 4 x ø4.6 = 12.4 (m³/h)  
 4 x ø5.5 = 13.9 (m³/h)

Dimensions (mm)

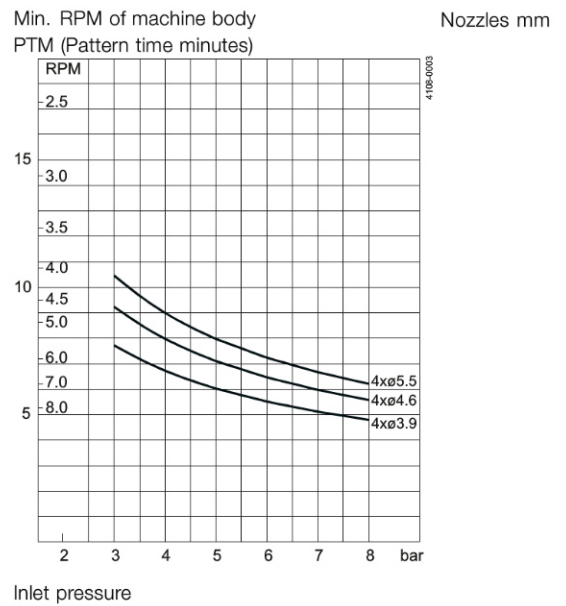
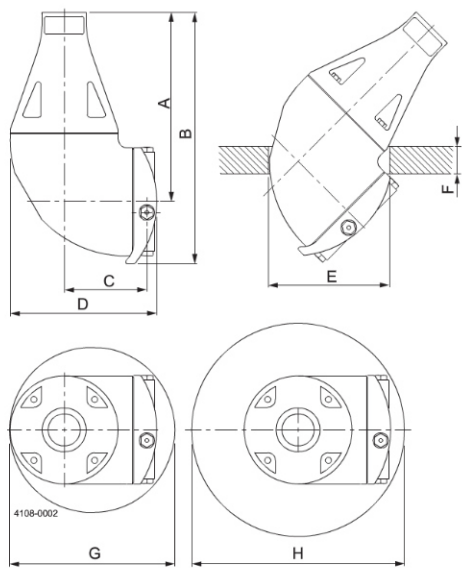

A	B	C	D	E	F	G	H
173	230	75	133	ø110	max. 25	ø150	ø200

**Standard Design**

The choice of nozzle diameters can optimise jet impact length and flow rate at the desired pressure. The Toftejorg TJ 20G is also available with PEEK impeller. A welding adaptor with sealing for 1" ISO, 1" ANSI, 1 1/2" ISO Dairy Pipe or 1 1/2" SWG Pipe is available as an accessory. The sanitary construction of the Toftejorg TJ20G is designed, with the aim to meet both European and American standards and regulations, such as EHEDG, USDA, USFDA, 3A etc. The TJ20G has been tested according to the EHEDG test procedure on cleanability and in-line steam sterilisability. As standard documentation, it can be supplied with a "Declaration of Conformity" for material specifications. Special distillery version available - see Price lists.

**TRAX simulation tool**

TRAX is a unique software that simulates how the Toftejorg TJ 20G performs in a specific tank or vessel. The simulation gives information on wetting intensity, pattern mesh width and cleaning jet velocity. This information is used to determine the best location of the tank cleaning machine and the correct combination of flow, time and pressure to implement.

A TRAX demo containing different cleaning simulations covering a variety of applications can be used as reference and documentation for tank cleaning applications. The TRAX demo is free and available upon request.

**Wetting Intensity**

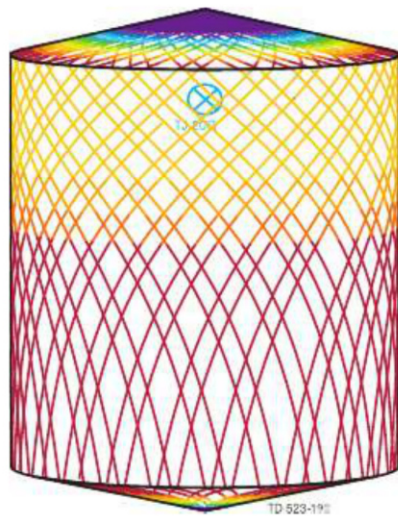
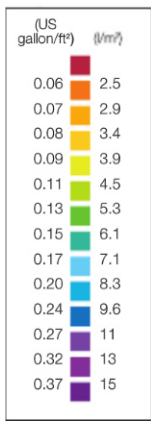

D4.6m H5.5m, Toftejorg TJ 20G, 4 x ø5.5 mm, Time = 2.08 min., Water consumption = 403 l



D4.6m H5.5m, Toftejorg TJ 20G, 4 x ø5.5 mm, Time = 8.3 min., Water consumption = 1612 l

